

Name: _____ Date: _____ Event: _____

Track: INDOOR OUTDOOR Size: SMALL MEDIUM LARGE Traction: LOW MEDIUM HIGH

Surface: SMOOTH BUMPY RUTTED Type: LOOSE / LOAMY HARD PACKED BLUE GROOVE CLAY ASTRO

Bumpsteer/Ackerman/Servo Saver/Steering Stop: _____ Condition: DUSTY DRY WET MUDDY

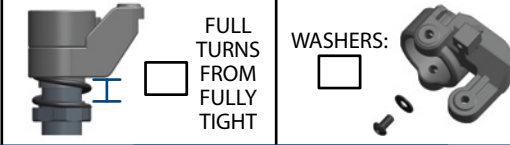
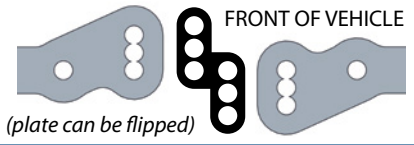
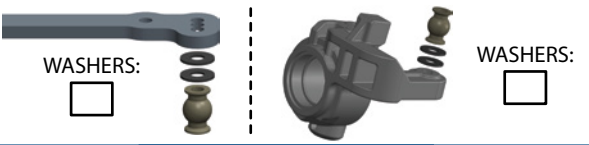

Front End:

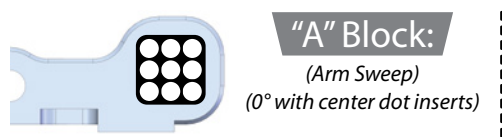
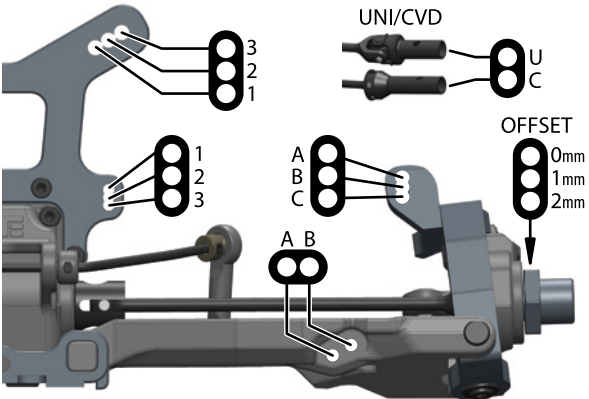

Suspension:

RIDE HEIGHT: _____ CAMBER: _____

CASTER BLOCK: _____ SWEEP: _____

KICK UP: _____ TOE: _____

SWAY BAR: _____ DROOP: _____

Shocks:

OIL: _____ BRAND: _____

PISTON: _____ SPRING: _____

REBOUND: _____ BUILD: _____

Differential Oil:

FRONT	CENTER	REAR
/	/	/
Drivetrain:		
PINION / SPUR: _____	/	(teeth)
Equipment:		

ESC: _____

BATTERY: _____

MOTOR: _____

SERVO: _____

Chassis Braces:

CENTER DIFF: REAR:

BATTERY INNER: BATTERY OUTER:

Tires / Wheels:

BRAND / TREAD: _____

COMPOUND: _____

INSERT: _____

WHEEL: _____

NOTES: _____

Body / Wing:

BODY MAKE: _____

WING MAKE: _____

Notes:

Rear End:

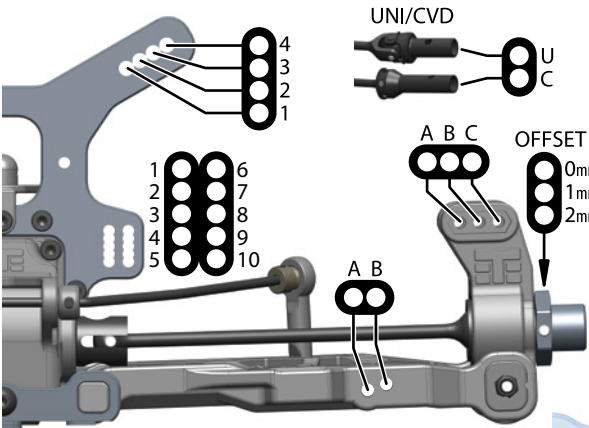

Suspension:

RIDE HEIGHT: _____ CAMBER: _____

ANTI-SQUAT: _____ TOE: _____

SWAY BAR: _____ DROOP: _____

Shocks:

OIL: _____ BRAND: _____

PISTON: _____ SPRING: _____

REBOUND: _____ BUILD: _____

Arm Inserts:

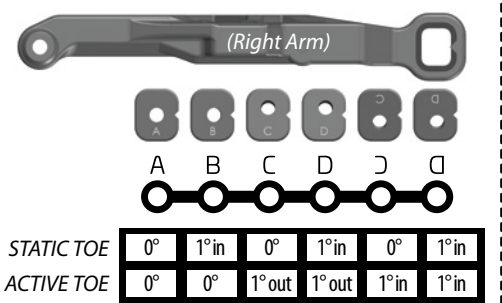

Rear Hub / Wheelbase:

